

LIVING DISTRICT

Collection: Collier

Installation manual for:

LD2314BK L19.1"W8"H9.8"L2

Installation instructions:

1. Black wire from ceiling(junction box) attaches to "L"wire from the fixture.
2. White wire from ceiling(junction box) attaches to "N"wire from the fixture.
3. "E" wire from the fixture is attached to the mounting bracket and an additional "E" wire from the mounting bracket must be secured to the junction box.
4. Secure mounting bracket to the junction box.
5. Insert screws(P2) in side of top unit the mounting bracket.
6. Fix the Mounting bracket(P1) to the Back plate and tighten by the Nuts(P4).
7. Fit lampshade(P10) with lampholder ring(P9).
8. Install the bulbs into the lamp fixture.(Bulb not included).

The end!

PARTS LIST

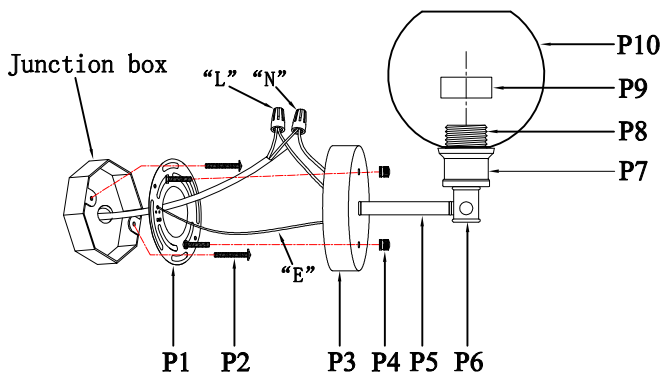

Side view

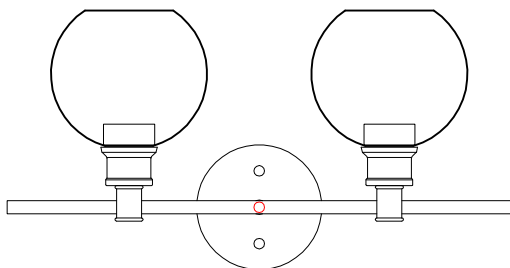

Front view

"L" = Hot wire
 "N" = Neutral wire
 "E" = Ground wire

part	picture	Description	Qty	Check list
P1		ø4.5" Mounting bracket	1	
P2		5/32-32 Screw	2	
P3		ø4.7" Metal Back plate	1	
P4		M5 Nuts	2	
P5		L3.4" Metal Tube	1	
P6		L19.1" Metal Tube	1	
P7		ø2.1" Metal Cup	1	
P8		E26 Lampholder	1	
P9		Lampholder ring	1	
P10		ø5.9" Lampshade	1	